

Termination

Termination is a kind of single-port micro-wave component which are fix to the end of the trauffer-system, it can absorb all the power of the incident-wave, without reflect according the eapacity of the power can divide, min-power and max -power , it is used for testing equipment distributing system indoor..

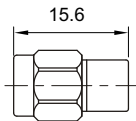
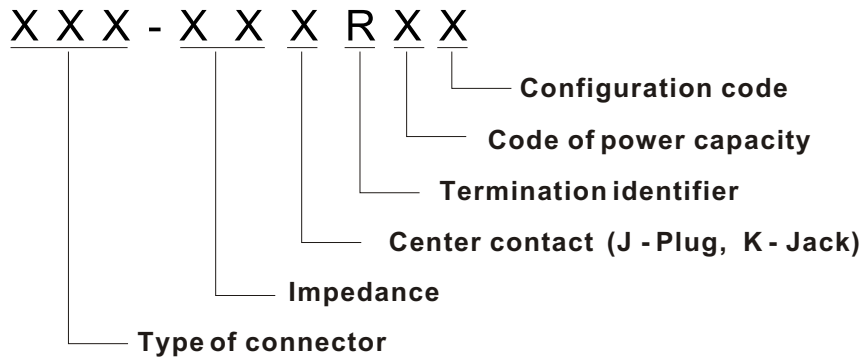

Type	part number	suitable cable
SMA-50JR	R031-0010	50 Ω

frequency range	VSWR	power capacity
0~18GHz	≤1.30	0.5 W

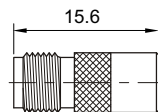
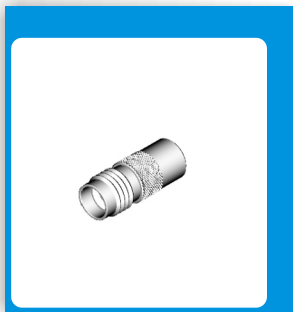

Type	part number	suitable cable
SMA-KR	R030-0010	50 Ω

frequency range	VSWR	power capacity
0~18GHz	≤1.30	0.5 W

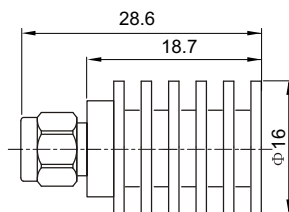
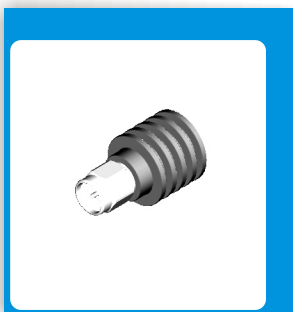

Type	part number	suitable cable
SMA-50JR-2W	R031-0020	50 Ω

frequency range	VSWR	power capacity
0~18GHz	≤1.30	2W

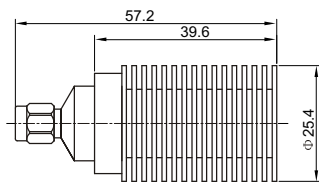

Type	part number	suitable cable
SMA-50JR-5W	R031-0050	50 Ω
frequency range	VSWR	power capacity
0~18GHz	≤1.30	5W

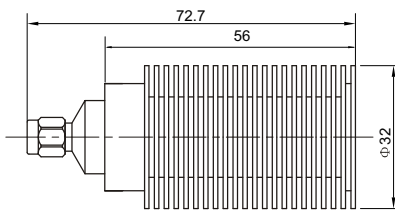

Type	part number	suitable cable
SMA-50JR-15W	R031-0251	50 Ω
frequency range	VSWR	power capacity
0~8GHz	≤1.30	15W

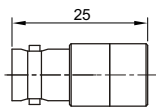

Type	part number	suitable cable
BNC-50KR	R080-0010	50 Ω
BNC-75KR	R540-0010	75 Ω
frequency range	VSWR	power capacity
0~2GHz	≤1.30	1W
0~1GHz	≤1.30	1W

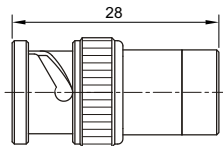

Type	part number	suitable cable
BNC-75JR	R541-0010	75 Ω
frequency range	VSWR	power capacity
0~1GHz	≤1.30	1 W

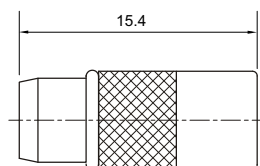

Type	part number	suitable cable
BMA-50JR	R011-0010	50 Ω
frequency range	VSWR	power capacity
0~18GHz	≤1.30	0.5 W

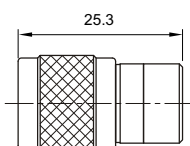

Type	part number	suitable cable
TNC-50JR	R071-0010	50 Ω
frequency range	VSWR	power capacity
0~11GHz	≤1.30	1 W

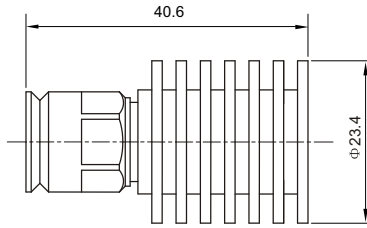

Type	part number	suitable cable
TNC-50JRG-5W	R071-0020	50 Ω
frequency range	VSWR	power capacity
0-8GHz	≤1.30	5W

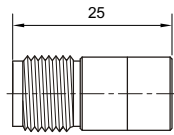

Type	part number	suitable cable
TNC-50KR	R070-0010	50 Ω
frequency range	VSWR	power capacity
0-8GHz	≤1.30	1W

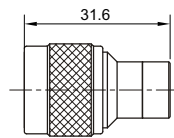

Type	part number	suitable cable
N-50JR	R061-0010	50 Ω
frequency range	VSWR	power capacity
0-8GHz	≤1.30	1W

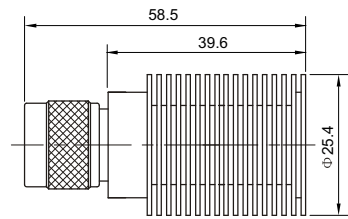

Type	part number	suitable cable
N-50JR-5W	R061-0052	50 Ω
frequency range	VSWR	power capacity
0-8GHz	≤1.30	5W

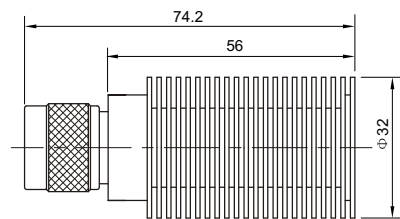

Type	part number	suitable cable
N-50JR-15W	R061-0251	50 Ω
frequency range	VSWR	power capacity
0-8GHz	≤1.30	5W

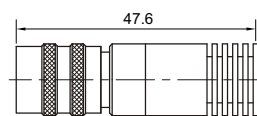
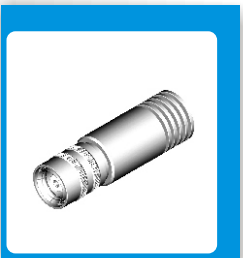

Type	part number	suitable cable
J.STWX8-50KR	R270-0011	50 Ω
frequency range	VSWR	power capacity
0.5~1.7GHz	≤1.30	2W