

SERIES SMA REVERSE POLARITY RF COAXIAL CONNECTORS

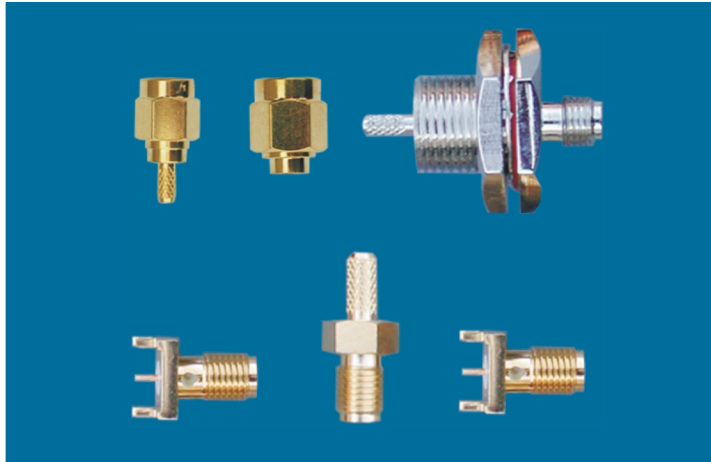

Key performance

Characteristic Impedance : 50Ω

Frequency range :

Flexible cable: 0~12.4 Ghz

Semi-rigid/comfortable cable: 0~18GHz

Contact resistance :

Center conductor $\leq 3.0m \Omega$

Out conductor $\leq 2.0m \Omega$

VSWR :

Flexible cable: $\leq 1.15+0.02f$

Semi-rigid/comfortable cable: $\leq 1.10+0.01f$

Insulator voltage withstanding : 750V

Connector durability : 500 cycles

Applicable spec/std: **MIL-STD-202**

Material

Center contacts:

Male---brass, gold plated.

Female---beryllium copper, gold plated

Bodies and other metal parts:

brass, gold plated

Insulators: Teflon

Crimp ferrule: copper, nickel plated.

Gasket and seal rings: silicone rubber

Heat-shrink tubing: thermofit plastic.

Interface Dimensions

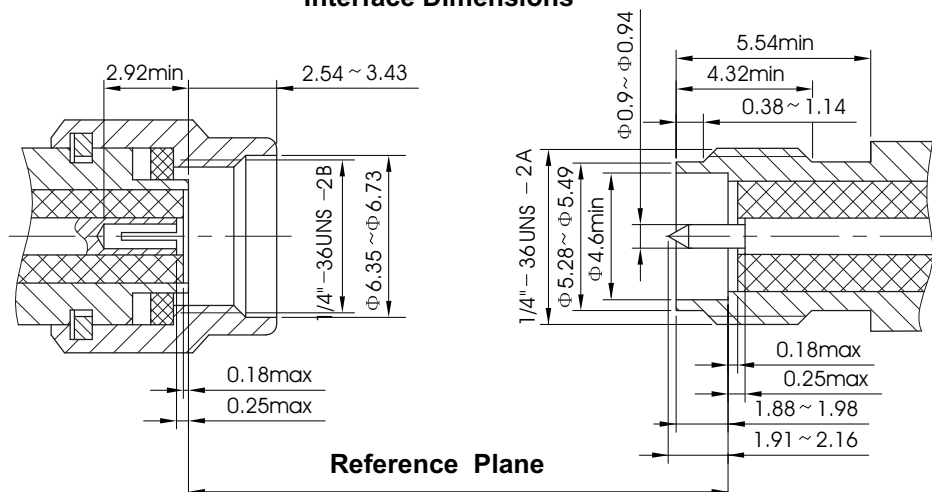

REVERSE POLARITY SMA



REVERSE POLARITY SMA

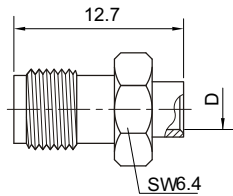

Type	part number	Suitable cable	D	Note
SMA-FJB2	8110-6601	B2	Φ2.2	
SMA-FJB3	8110-6602	B3	Φ3.6	

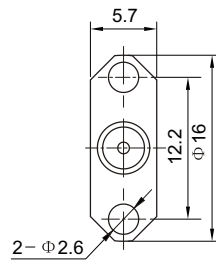
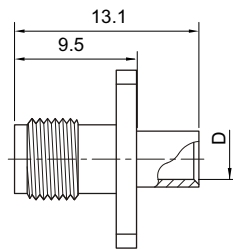
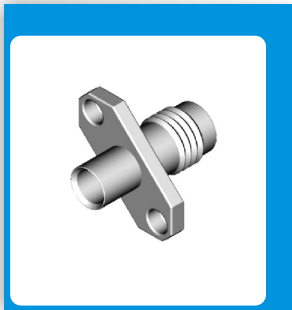

Type	part number	Suitable cable	D	Note
SMA-FJFB2	8110-1601	B2	Φ2.2	
SMA-FJFB3	8110-1602	B3	Φ3.6	

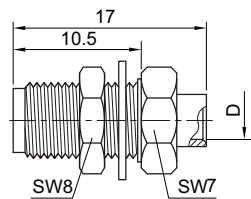

mounting hole

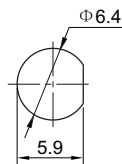

Type	part number	Suitable cable	D	Note
SMA-FJYB2	8110-2601	B2	Φ2.2	
SMA-FJYB3	8110-2602	B3	Φ3.6	

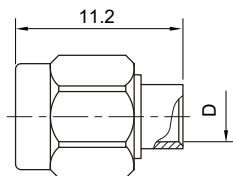
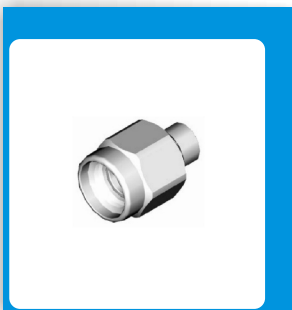

Type	part number	Suitable cable	D	Note
SMA-FKB2	8120-6601	B2	Φ2.2	
SMA-FKB3	8120-6602	B3	Φ3.6	

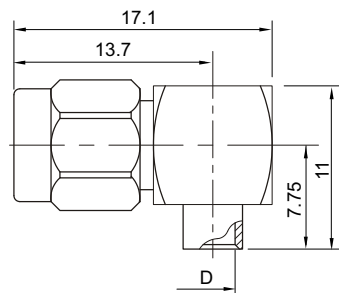
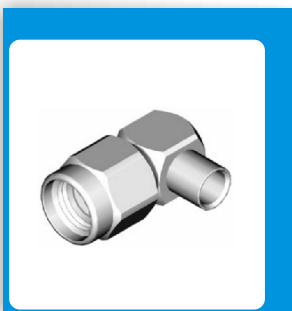

Type	part number	Suitable cable	D	Note
SMA-FKWB2	8140-6601	B2	Φ2.2	
SMA-FKWB3	8140-6602	B3	Φ3.6	

REVERSE POLARITY SMA



REVERSE POLARITY SMA

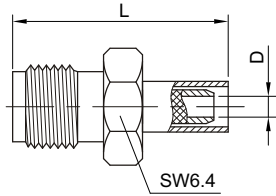

Type	part number	Suitable cable	L	D	Note
SMA-FJ3	8110-6501	3	18.6	Φ1.6	
SMA-FJ5	8110-6502	5	24	Φ2.3	

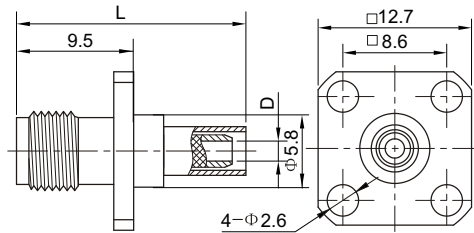
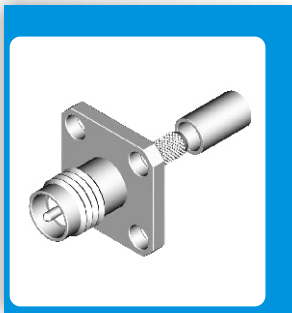

Type	part number	Suitable cable	L	D	Note
SMA-FJF3	8110-1501	3	18.5	Φ1.6	
SMA-FJF5	8110-1502	5	24	Φ3.1	

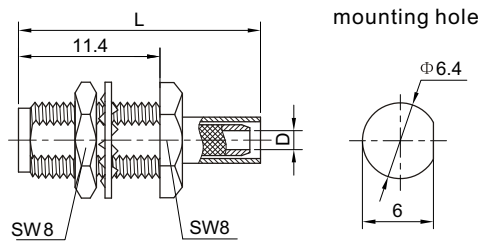
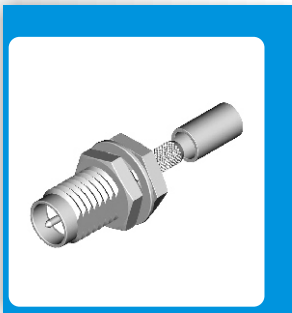

Type	part number	Suitable cable	L	D	Note
SMA-FJY3	8110-2501	3	19.9	Φ1.6	
SMA-FJY5	8110-2502	5	25.3	Φ3.1	

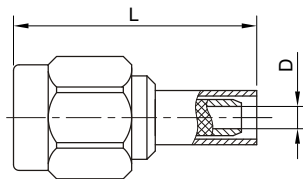

Type	part number	Suitable cable	L	D	Note
SMA-FK3	8120-6501	3	18.1	Φ1.6	
SMA-FK5	8120-6502	5	25.5	Φ3.1	

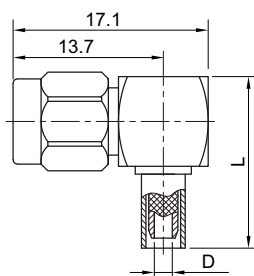
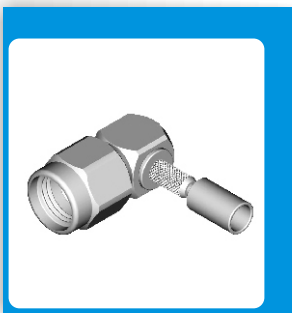

Type	part number	Suitable cable	L	D	Note
SMA-FKW3	8140-6501	3	13.8	Φ1.6	
SMA-FKW5	8140-6502	5	19.3	Φ3.1	